

# P-SENSOR AIR PRESSURE AIR VOLUME

- Ultra low pressure and velocity measurement
- Traceable Calibration Certificate is included
- High accuracy and repeatability
- Linear pressure or air volume output
- Both measurement and PID control output
- One Modbus for monitoring or remote display
- Alarm LED indicators and threshold limits
- Auto Zero and overload protection is standard
- Operator keyboard input for all functions
- Modbus rtu, 0..10V and 4..20mA output
- IP65 enclosure with easy mount wall brackets
- 24 month warranty
- 30 Years field application experience



*P-SENSOR Wall Mount with Keyboard and LED display*

## GENERAL

The P-Sensor is a wall mount ultra low pressure transmitter which provides 0..10V and 4..20mA as well as Modbus communication over the selected range. The display can be adjusted via the keyboard to show the measured value in Pa, hPa, kPa, m/s, l/s, m3/s, m3/h and ACR (air change rate).

A PID control output can be selected, but still having one output for monitoring the pressure or volume.

The pressure ranges can be adjusted via the keyboard, but the base range is factory calibrated and certified i.e. 10, 25, 50, 100, 250 and going up to 7500 Pa. All ranges can be adjusted to +/- ie. -/+25Pa.

Power supply 24Vdc/ac non-isolated or 24, 110 and 230Vac isolated are available as standard.

## CMR TRANSDUCER

The transducer is manufactured by CMR with high precision engineered components. The principle is the measurement of the displacement of the diaphragm by means of a push and pull variable reluctance circuit which is not affected by humidity and hence it can be used in any industrial or commercial environment. There are no mechanical connections to any of the sensing coils and the diaphragm.



*CMR Transducer*

Extremely low pressures can be measured with excellent repeatability and minimal hysteresis. The diaphragm displacement is so small that no air volume is required to measure the air pressure which means measurement tubing can be connected in excess of 200m throughout the building without losing accuracy or measurement speed.

The zero drift is minimized by the measuring copper coils which are matched to provide excellent self compensation. One coil measures positive and the other negative drift and therefore balances any excessive drift between two tolerance limits in its life cycle. The CMR Transducer has a proven field track record of over 30 years. All CMR Sensors are temperature compensated in a computerised climate chamber.



*CMR Climate Chamber*

## KEYBOARD DISPLAY

A combined keyboard and LED Display is fitted into the lid and is connected to the P-Sensor board with a plug-in ribbon cable. All parameters can be accessed via the key pad. The display can also be programmed to switch off after a time and by touching a key to light up again. Normally it is always on.

## PARAMETER CONFIGURATION

The duct width and height can be entered as well as the density and (mf) magnification (K) factors to scale Fan Inlet Rings, Flowgrids, Veloprobes, Oval Flowprobes, Venturis or any other velocity pressure producing probes. The volume can be linearized over 8 points to provide extremely high accuracy in measurement.

The range can be changed from i.e. -10 Pa to 30 Pa or -20 to 120 Pa. The output signals can be changed to i.e. 2..10V, 1..5V or 5..19mA.

The auto zero function is built in, which is of great advantage at very low velocity pressure measurement i.e. 0.3 Pa to have an accurate base point at all times. The auto zero can be turned off where it is not required.

The overload protection can be switched on and is ideal to protect the low pressure diaphragm. It is active whenever the sensor is powered up.

One of the outputs can be configured to be a PID control to drive fan inverters or modulating dampers and the other can be used for the actual pressure or air volume measurement for the BMS or PLC system. The set point can be sent from the BMS via modbus.

The signals can be individually smoothed. The control output can be fast but the measurement output can be damped.

A calibration mode can be selected so that all of the parameters remain the same as commissioned and only the base sensor shall be calibrated and displayed in Pa.

## MODBUS rtu COMMUNICATION

The modbus communication can be used to read and write all parameters by the remote Host which can be the BMS, PLC or PC.

## REMOTE ALARM DISPLAY

A remote display DIS110 without alarm or DIS125 with alarm and mute button can be connected via Modbus if the modbus is not used for the BMS. The alarm button has green and red Led light rings to show healthy or alarm status. A buzzer is also fitted. A separate power supply must be wired to the display.



*Remote Display Plate*

**CMR CONTROLS** Ltd  
Precision Air Pressure and Volume Sensors

22 Repton Court Repton Close  
Basildon Essex SS13 1LN GB  
web www.cmr-controls.com

Phone +44 (0) 1268 287222  
Fax +44 (0) 1268 287099  
mail sales@cmr-controls.com



# P-SENSOR AIR PRESSURE APPLICATION

## ROOM PRESSURE MEASUREMENT WITH CMR P-SENSORS



Tubes + Fittings



Ceiling Air Probe



Air Probe Plate

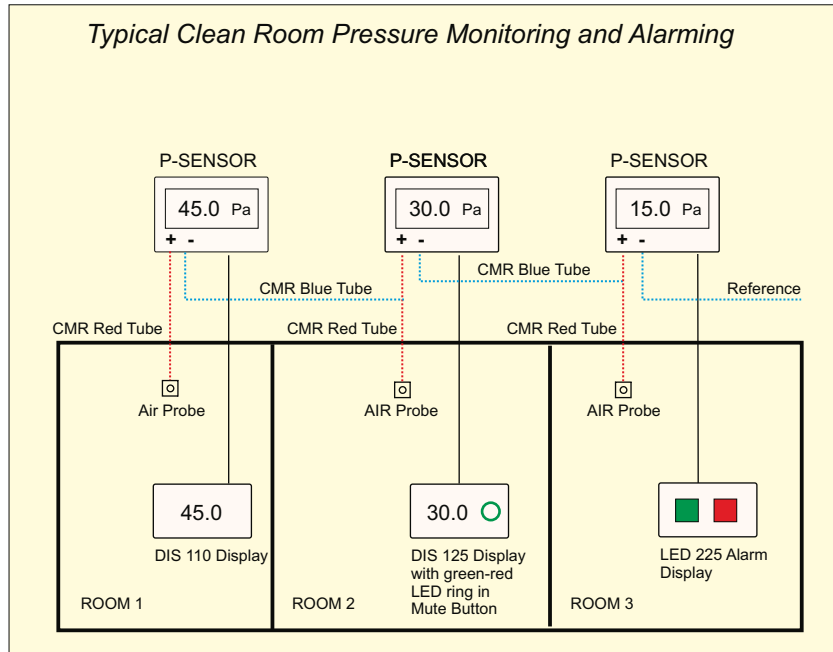

DIS 110 Display



DIS 125 Display

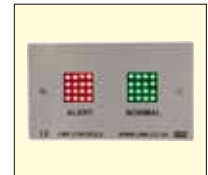

LED 225 Display

The above schematic shows a typical clean room. The room pressures are measured in cascades starting in Room 3 from a reference such as a plant room or any other stable location, then measuring across to room 2 and finally across to Room 1.

Each room has an air probe plate fitted to the ceiling. The air probes are connected to the P-Sensors with red and blue CMR PVC Tubing.

The CMR PVC tubing can be run up to 200m from the room to the P-Sensor without losing accuracy of the measurement.

Remote LED display plates are fitted for the operators to see the actual room pressure in Room 1 and 2. Room 2 has also a local illuminated alarm green and red led built as ring into the mute button and a buzzer. Room 3 has only a modbus alarm led indicator plate.

The P-Sensor is a true Low Differential Air Pressure Transmitter and can be used for static pressure, vacuum pressure and differential pressure measurements in positive or negative areas.

The operator keyboard with LED display is fitted into the lid as standard and shall display the actual pressure. All parameters can be adjusted without opening the lid.

The Pressure measurement can be transmitted via modbus rtu or analogue signals 0..10V or 4..20mA to the SCADA, BMS or industrial PLC systems for long term monitoring.

All future calibration can be done using the calibration mode. Calibration Certificates traceable to National and International Standards (UKAS) are supplied as standard with all P- Sensors.

## TYPICAL PRESSURE APPLICATIONS

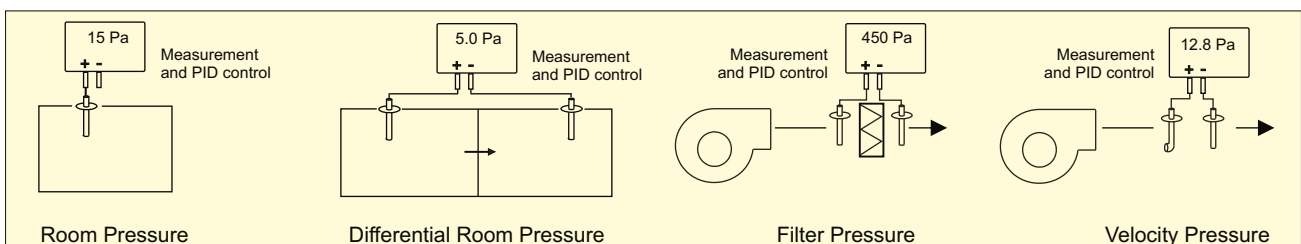
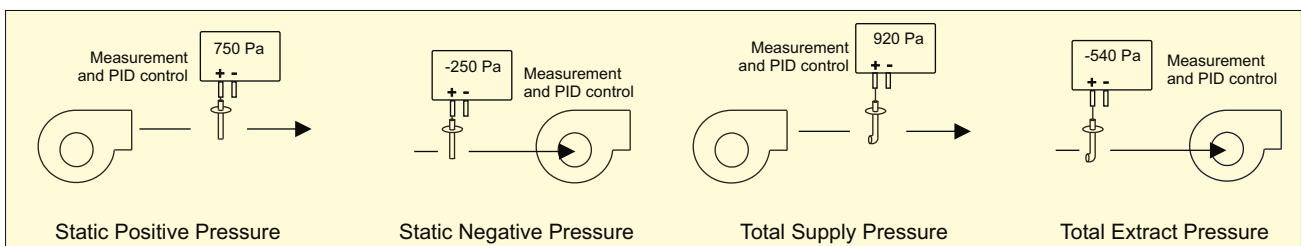

# P-SENSOR AIR VOLUME APPLICATIONS

VELOCITY PRESSURE AND AIR VOLUME MEASUREMENT WITH CMR P-SENSORS

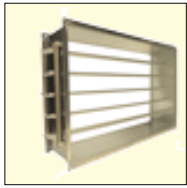

FGG Flowgrid



VVM Venturi



PVC Tube Fittings

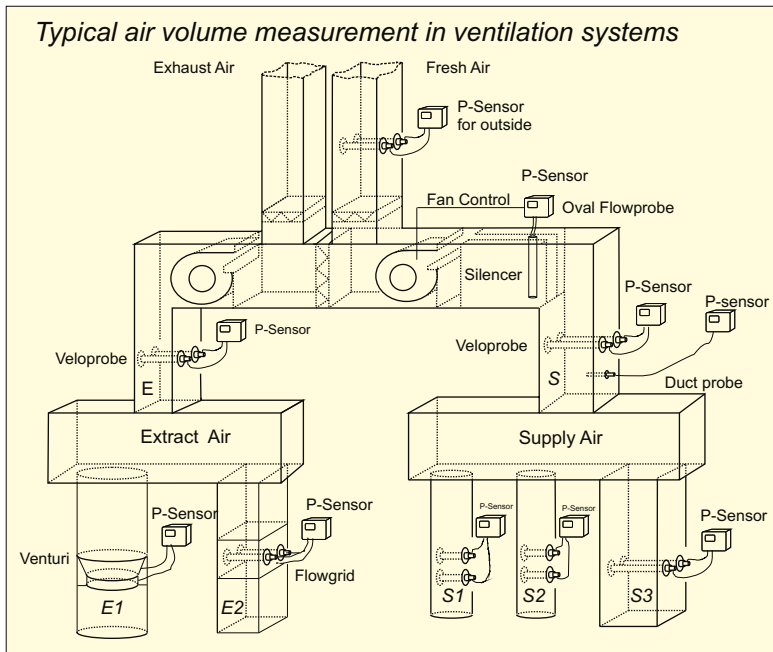

CMR Veloprobes



Duct Probes



Oval Flowprobe

The CMR P-Sensor is an ultra low high precision Velocity Pressure Transmitter which has been designed to accurately measure air volumes in Ventilation Ducts . The built in Square Root Extraction and Magnification Factor Scaling makes the P-Sensor an extremely versatile measurement instrument.

It can display the actual volume in m3/s. Other Units such as m3/h, litres/s or ACR ( Air change rate) can be selected via the keyboard. Any imperial measurement units i.e. CFM are available on request .

The CMR PVC tubing can be run up to 200m from the sensing station to the P-Sensor without losing the accuracy of the measurement.

The P-Sensor is used for monitoring and also controlling Volume Flow in Commercial or Process Applications and is designed to be connected to any CMR Veloprobes, Duct Probes, Flowgrids, Venturis and Fan Inlet Rings. It can also be used with any existing or custom made duct Flow Measurement Device.

The measured values can be transmitted to remote display plates, SCADA, BMS control systems or industrial PLCs through the output signals of 0..10V, 4...20mA and modbus.

Calibration Certificates traceable to National and International Standards (UKAS) are supplied with all P-Sensors.

## TYPICAL CMR AIR VOLUME MEASUREMENT APPLICATIONS

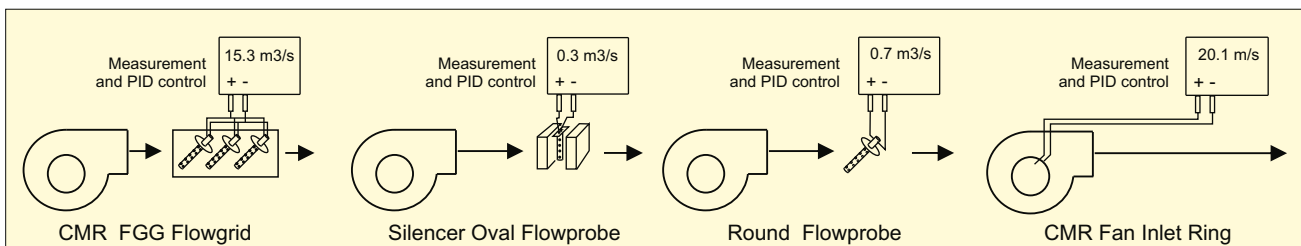
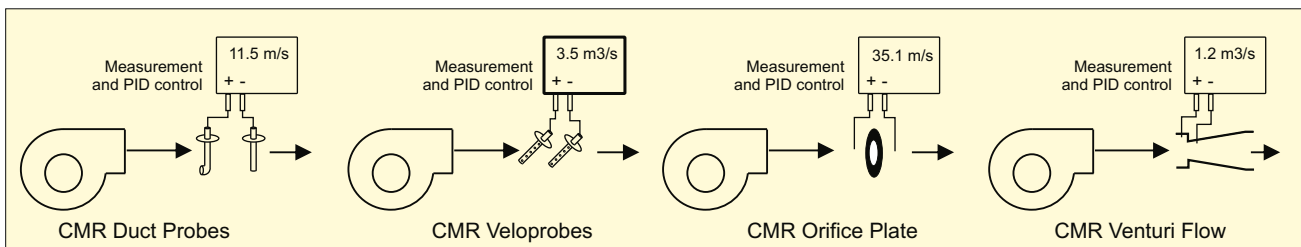

**CMR CONTROLS** Ltd  
Precision Air Pressure and Volume Sensors

22 Repton Court Repton Close  
Basildon Essex SS13 1LN GB  
web www.cmr-controls.com

Phone +44 (0) 1268 287222  
Fax +44 (0) 1268 287099  
mail sales@cmr-controls.com



# P-SENSOR VELOPROBE MEASUREMENT

## GENERAL

The drawing shows a typical application for CMR Veloprobes and P-Sensors.

The supply air duct can either be fitted with one central Veloprobe or individual Veloprobes on each of its branches.

In many cases, the positions of the Veloprobes are very much dictated by the design of the building. The CMR Veloprobe can be fitted in almost any position in order to provide accurate measurements.

In a single supply and extract duct application, the P-Sensor measures the building's actual total supply and return volumes. As both P-Sensors are calibrated to provide a linear air volume signal, tracking of supply and extract air is now made easy.

The duct height, width or diameter, density and magnification ('K' factors) can be entered in the P-Sensor via the keyboard very easily and only the measurement range for 0..10V or 4..20mA must be given to the BMS at final commissioning.

For multiple duct applications, the total supply and extract air volume is derived by adding all air volumes from the individual ducts.

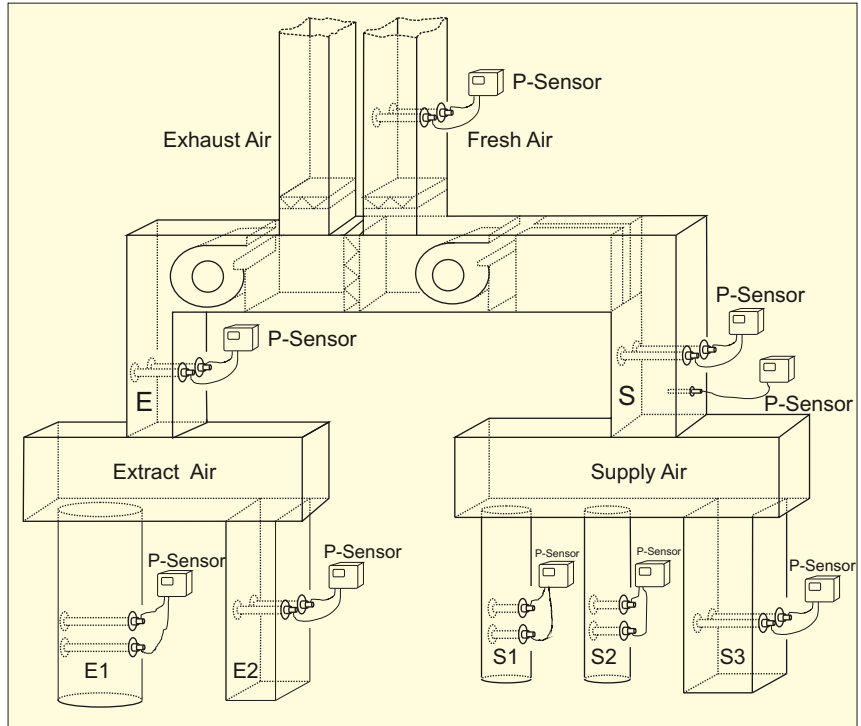

Example of Volume adding:  $S = E \pm \text{an offset for positive or negative building pressure}$   
 $S1 + S2 + S3 = E1 + E2 \pm \text{offset or } S = E1 + E2 \pm \text{offset} - \text{etc}$

### P-Sensor - scaling in m/s only.

Adjust the Impact Veloprobe (red) to face the Airflow and and adjust the Static Veloprobe (blue) to approx. 180° away from the airflow.

### Scaling of the duct height and width is done in the BMS

Use the keyboard and adjust the display to m/s. Adjust the height and width to 1 and adjust the (mf) to 2.000. Press the very left hand key briefly and the sensor range is displayed for a short time, which is the range at 10V in m/s. If the range of the sensor is 100Pa then it should display 9.128 m/s.

Take a Pitot Tube reading in the duct and if the velocity is not equal to the display then adjust the magnification factor until it is equal then press the range key again to get the new range in m/s.

### P-Sensor - scaling in m3/s - m3/h - l/s - ACR air change rate

Adjust the Impact Veloprobe (red) to face the Airflow and and adjust the Static Veloprobe (blue) to approx. 180° away from the airflow.

### Scaling the range for the BMS

Use the keyboard and enter the duct height and width or simply enter the width of a round duct and keep the height at 0. Adjust the magnification factor (mf) to 2.000. Use the display key and select m3/s, m3/h, l/s or ACR (Air Change Rate) and adjust the decimal places. When pressing the left hand key the sensor range shall be displayed in the selected units at 10V. Take a Pitot Tube reading in the duct and if the volume is not equal to the display then adjust the magnification factor until it is equal then press the range key again to get the new range.

### P-Sensor air volume measurement with Veloprobes in Duct

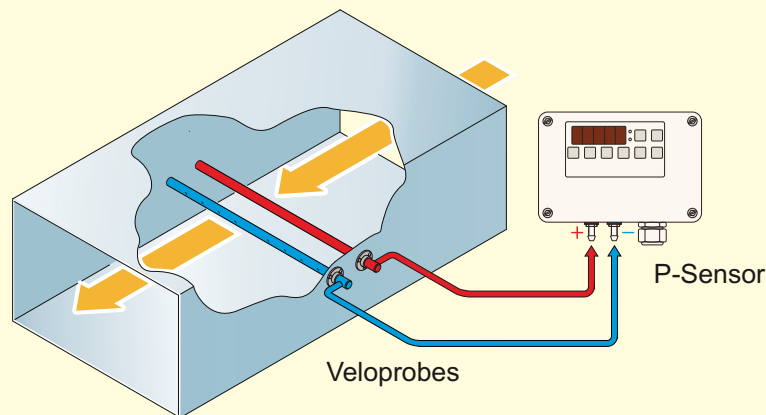

# P-SENSOR

# KEYBOARD FUNCTIONS

FUNCTIONS (Use Operator Manual for full Instructions)

The P-Sensor LED-Keyboard has been designed to simplify installation and commissioning. The only time the lid must be opened is for wiring during installation. Thereafter every control function can be accessed via the keyboard, even the calibration can be carried out utilising this functionality.

## ZERO KEY

When pressing the zero key for 1 seconds, the P-Sensor shall perform a zero which means the pressure is taken off the sensor internally and the diaphragm is relaxed to zero.

## PASSWORD

The keyboard can be password protected so that only the display can be operated, but no adjustments can be made.

## RANGE KEY

Pressing the range key very quickly once will display the sensor range i.e. if it shows 100, this means the range of the sensor has been configured to 0-100Pa for 10V/20mA output. By pressing the range key for 1 seconds it enters the configuration menu:

S	Software Version	1.5
Ad	Network Address	1-254 (0 Denotes Modbus Display)
AZ	Auto Zero	on - off
P	Positive Range	i.e. + 25
n	Negative Range	i.e. - 25
Opp	Over Pressure	1(on) 0(off)
F	Zero Offset	
t	Set Point	
Sn	Modbus smoothing	d or o
Adj	Internal / External	I or E
Azt	Auto Zero time interval	1-99 h
FF	Modbus float format	0-3

## OUTPUT KEY

Pressing the output key very quickly once will display the sensor output configuration i.e. lin or root, which means the sensor measures pressure or airflow. By pressing the output key for 1 seconds the configuration menu can be reached:

So	Output Smoothing	0-99
Lin	Output mode	linear pressure
root	Output mode	square root
e	Output scaling	F, L or Fac
F	Mag Factor	0-99.99
_	Duct width	0-9999mm
l	Duct height	0-9999mm
d	Air Density Factor	0-9.99kg/m3
r	Room Size	0-9999m3
s	Small Value Shut off	0-99.99%
o	Output Re-Scaling	
bFl	Bi-Directional Flow	0 or 1

## DISPLAY KEY

Pressing the display key very quickly once will display the measurement units. i.e. Pa, hPa, kPa etc, and is the units the sensor has been configured to i.e. Pa. By pressing the display key for 1 seconds it enters the configuration menu:

Sd	Display Smoothing	0-99
Pa	Pascals	
hpa	hecta Pascals	
3pa	kPa	
nnps	metres per second	
lps	litres per second	
nn3s	cubic metres per second	
nn3h	cubic metres per hour	
acr	Air Change Rate per hour	
dp	Decimal Place	0-4
pos	Display polarity (+)	
neg	Display polarity (-)	
Led	Display Activation	1 or t
L2b	Leading Zero Blanking	1 - 4

P-SENSOR WITH STANDARD LED DISPLAY AND KEYBOARD

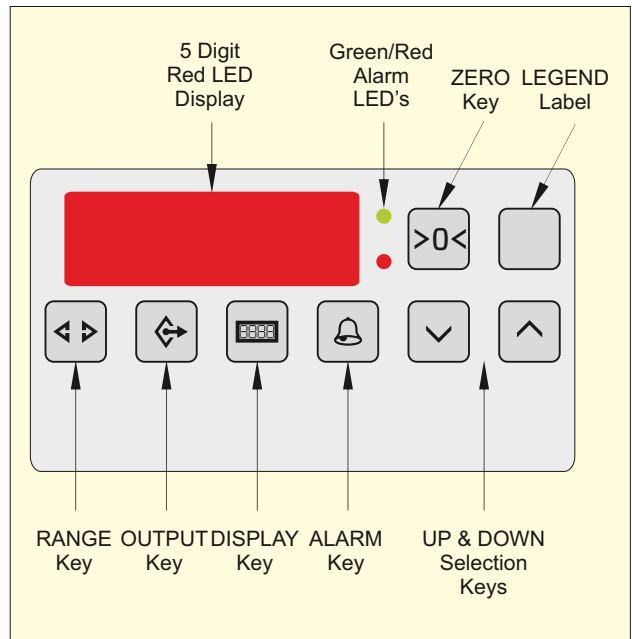

## ALARM KEY

Pressing the alarm key quickly shall not have any action as the P-Sensor has no alarm buzzer built in. By pressing the alarm key for 1 seconds it enters the configuration menu:

L	Low Alarm	
H	High Alarm	
t	Alarm timer 1	0-9999
t.	Alarm timer 2	0-9999
u.	Units	dU (Display Units) or Per (%)
af	Alarm Function	0-2
Sr	Self Reset	0-1
rb	Remote Buzzer	-, 0, 1 or P
rA	Remote Alarm Indication	-, 0, F or LH
rt	Re-alarm timer	0-999 minutes
tU	Alarm timer units	s or h

## UP - DOWN KEY

The up and down keys are used to select the various parameters

## OUTPUT SIGNAL

0-10V and 4-20mA are also available on J7.

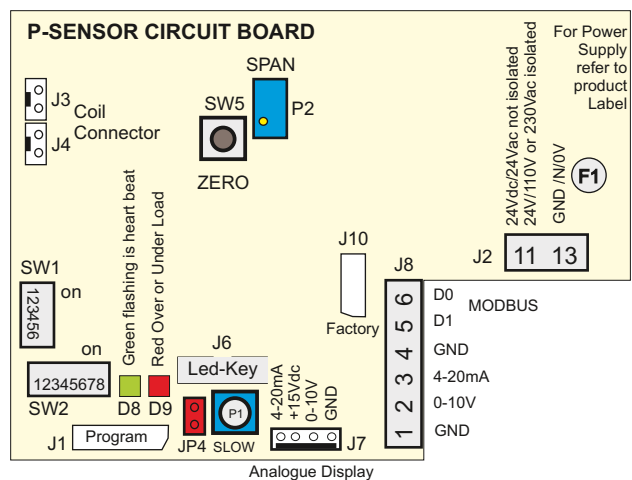

P-SENSOR CIRCUIT BOARD



# P-SENSOR

# ORDER DESCRIPTION

## GENERAL

CMR manufactures the P-Sensors to suit many low pressure and volume measurement applications. Because of the variety of pressure ranges, output signals and power supplies it has been necessary to design an easy to use selection table for anybody to make up a P-Sensor specification to satisfy a requirement. On the P-Sensor Selection Table you will find all specifications available with the associated ordering code.

## P-SENSOR BASE PART NUMBER

The P-Sensor Part Number starts with a base part number of the type of sensor. Code '23' which is a P-Sensor in a standard ABS enclosure.

The Part Number therefore starts with '23'.

## P-SENSOR ISSUE No

The P-Sensor will have a version number to identify the model. The Code is '1' for version 1'.

The Part Number extends to '231'

## TUBE CONNECTORS

6 mm barbed nipples to fit CMR PVC Tube are fitted as standard into the ABS box. They have the Code 'A'.

4 mm barbed nipples to suit the CMR Silicone Tube are also available as Code 'B'.

The example has 6 mm barbed nipples, which is standard.

The Part Number therefore extends to '231A'.

## NEGATIVE PRESSURE RANGE

The Negative Range is specified as (-). If the application requires to measure a negative pressure against a reference, i.e. a room has to be at negative pressure compared with the corridor then the room has to be connected to the Red or (+) nipple. The blue (-) nipple shall be connected to the reference in this case the corridor.

The negative room pressure shall suck on the red (+) nipple and the P-Sensor produces an output signal equivalent of the negative pressure measured.

In the Example we have chosen -25 which has the Code '0025'.

The Part Number extends to '231A0025'.

If the P-Sensor must only measure in the positive Range i.e 0-25 then the Negative Range will always be selected as 0 and the Code is always '0000'.

## PRESSURE UNITS

The negative pressure and the positive pressure range must be expressed in units i.e. Pa. The CMR transducers are in Pascals (Pa) as standard.

In the example Pa was selected with Code 'P'.

The Part Number extends '231A0025P'

## POSITIVE PRESSURE RANGE

To measure Positive Pressure against a reference it is necessary to select a positive range i.e. +25. The Code is '0025' This means the P-Sensor selected above can measure from -25 Pa to 0 and from 0 to +25 Pa. The output Voltage would therefore be 5V or 12mA at 0 Pa.

The Part Number extends to '231A0025P0025'

## LABEL UNITS

As the P-Sensor has a fixed label next to the LED display, i.e. Pa, kPa, hPa, mB, m/s, m3/s, m3/h, l/s etc. It is necessary to specify the label when selecting the part number as this is all part of the validation of the instrument.

In the example Code 'P' for Pa was selected.

The Part Number extends to '231A0025P0025P'

## OUTPUT SIGNAL

The Industry Standards for Output Signals are 0-10V or 4-20mA, but other signals can be adjusted via the keyboard.

If 0-10V is the Output Signal for -25 Pa to +25 Pa then 5 V is 0 Pa. From 5V to 0V the P-Sensor measures from 0 Pa to -25 Pa i.e. (-)12.5 Pa would be 2.5V.

From 5V to 10V the P-Sensor would measure positive Pressure from 0 Pa to +25 Pa i.e. +12.5 Pa would be 7.5V.

It is standard to use equal ranges -25 Pa to +25 Pa rather than -25 Pa to +50 Pa but the P-Sensor can be adjusted via the keyboard to provide any offset.

In the Example, we have selected the standard Dual (0..10V & 4..20mA) which has the Code '1'.

The Part Number extends to '231A0025P0025P1'

## POWER SUPPLY

CMR can supply 24Vdc/24Vac Non-Isolated which does not have an isolation transformer and is also suitable for 3-Wire connection. Most common is the 24Vac Isolated. 110Vac and 230Vac are less used, but also selectable. In the example we have selected 24Vac which has the Code '3'.

The Part Number extends to '231A0025P0025P13'.

## FINAL PART NUMBER

The Part Number to order is '231A0025P0025P13'

**Now try and select your own P-Sensor using the P-Sensor Order Selection Table.**

# P-SENSOR ORDER SELECTION TABLE

The Selection Table has been prepared to make ordering easy. Each column contains a number of different options which are available and a Part Number can be established depending on a specific requirement.

The Example Part Number 231A0025P0025P13 which is printed above the Selection Table and identified as being a P-Sensor with ABS enclosure, having an LED Display and Keyboard, with 6mm barbed tube connectors, a Negative Pressure Range of -25, Range Units in Pa (Pascals) and a Positive Range of +25, labelled in Pa (Pascals) with Dual Output Signals of 0-10V & 4-20mA, which would mean in this case 0 Pa is 5V & 12mA. The Power Supply is an isolated 24Vac (4 wire).

The P-Sensor would be supplied with a 5 digit LED-Display-Keyboard mounted into the Lid and the measured Units are Pa (Pascals). The Decimal Point is user adjustable to 1 on the keyboard which indicates from -25.0 Pa to +25.0 Pa It comes standard with a traceable calibration certificate to national and international Standards (UKAS).

## EXAMPLE PART NUMBER SELECTION ( The code after the (=) sign is used i.e. 6mm = A)

23	1	A	0025	P	0025	P	1	3
P-Sensor	ISSUE	Nipple	Negative	Range	Positive	Label	Output	Power
Part No.	No	Size	Range	Units	Range	Units	Signal	Supply
Base = 23	Issue = 1	6mm = A	0000	Pa = P	0000	Pa = P	Dual = 1	24Vdc/ac = 2
		4mm = B	0010		0010	kPa = K		24 Vac = 3
			0025		0025	mB = B		110 Vac = 4
			0030		0030	hPA = H		230 Vac = 5
			0050		0050	m/s = V		
			0060		0060	m3/s = Q		
			0100		0100	m3/h = M		
			0120		0120	l/s = L		
			0125		0125	ACR = A		
			0150		0150			
			0200		0200			
			0250		0250			
			0500		0500			
			0750		0750			
			1000		1000			
			1250		1250			
			1500		1500			
			2000		2000			
			2500		2500			
			5000		5000			
			7500		7500			

## HOW TO ORDER

--	--	--	--	--	--	--	--	--

### EXAMPLE

A wall mount pressure transmitter is required of the Type P-Sensor  
 An LED complete with Keyboard is required as standard.  
 The tube connections must be 6mm for CMR PVC Tube.  
 The negative pressure range must be -100 Pa  
 The measured units must be in Pascals (Pa)  
 The positive pressure range must be +100Pa  
 The units on the LED display must in Pa as well as on the Product label.  
 The output signal must be Dual (0-10V & 4-20mA)  
 The power supply must be 24Vdc non-isolated

Call CMR for assistance at any time

The part Number for this P-Sensor is 23 1 A 0100 P 0100 P 1 2

# P-SENSOR TECHNICAL SPECIFICATION

Measurement Range	Any Range from 0-25Pa or +/-25Pa up to 0-7500Pa or +/-7500Pa
Overload Capacity	Ranges 25Pa - 150Pa up to max 1200Pa if over pressure protection is off.
	Ranges from 200Pa - 7500Pa up to max 10 times of range if over pressure protection is off.
Media	Non corrosive gases such as Air, N2, O2, Co2, N2O and inert gases
Diaphragm Unit	Beryllium Copper suitable for high concentration of Formaldehyde - Stainless Steel on request.
AC Power Supplies	24 Vac 50/60Hz 130mA. Internal Fuse 300mA Auto-Reset.
Transformer Isolated	110Vac 50/60Hz 32mA. Fuse 315mA Wickmann
	230Vac 50/60Hz 16mA. Fuse 315mA Wickmann
DC/AC Power Supplies	24 Vdc (19 to 31Vdc) smoothed 80mA or 24Vac non isolated. Internal Fuse 300mA Auto-Reset.
Voltage Output Signal	0-10V (0 to100% of Range) RL = 5kOhm min. Other output signals (e.g. 2-10V) or PID loop control is programmable via keyboard.
Current Output Signal	4-20mA (0 to100% of Range) RL = 500 Ohm max. Other output signals (e.g. 0-20mA) or PID loop control is programmable via keyboard.
Modbus rtu Connection	Output Signal, Alarm Status, Alarm Thresholds and Alarm Timers are all readable as Modbus rtu Commands. Modbus rtu register assignments to read and write are available in the operator manual.
Hysteresis/Repeatability	0.1% Typical of Full Scale.
Linearity (Accuracy)	+/- 0.25% of Full scale = > 100 Pa and 0.25Pa < 100Pa.
Zero Drift	0.05%K (+10°C to +50°C) - Automatically corrected to 0.0 if Auto-Zero function is enabled.
Operating Temperature	-10°C to +70°C.
Mounting Position	Vertical.
Weight	0.6 kg in ABS Housing.
Electrical Connections	ABS Housing: 1 x M20 Gland. Internal removable Screw Terminals.
Air Tube Connections	ABS Housing: Positive and Negative Pressure Barbed Nipple 6mm OD x 15mm long for CMR PVC Tube Alternatively Barbed Nipple 4mm OD x 15mm long for silicone tube on special request
Enclosure	Plastic (ABS) Light Grey (RAL7035) - Protection IP65. EN61326-1 EMC - EN61010-1 SAFETY.
Calibration Certificate	Supplied with Certificate traceable to national and international Standards (UKAS).

## DIMENSIONS AND CONNECTIONS

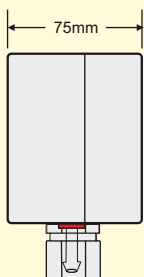
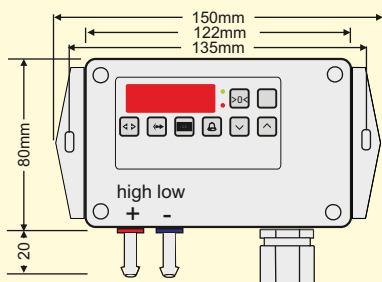

P-Sensor in ABS Enclosure

**TUBE CONNECTIONS**  
2 x 6mm Barbed x 15mm for CMR PVC tube

**CABLE ENTRY**  
1 x M20 Gland for ABS Enclosure

