

# P-SENSOR AIR PRESSURE-AIR VOLUME

- Ultra low pressure and velocity measurement
- UKAS traceable calibration certificate is included
- High accuracy and repeatability
- Linear pressure or air volume output
- Both measurement and PID control output
- Modbus rtu for monitoring or remote display
- Alarm LED indicators and threshold limits
- Auto Zero and overload protection is standard
- Operator keyboard input for all functions
- Modbus rtu, 0-10 V and 4-20 mA output
- IP65 enclosure with easy mount wall brackets
- 24 month warranty
- 40 Years field application experience



P-SENSOR Wall Mount with Keyboard and LCD Display

The P-Sensor is a wall mount ultra low pressure transmitter which provides 0-10 V and 4-20 mA as well as Modbus communication over the selected range. The display can be adjusted via the keyboard to show the measured value in Pa, kPa, m/s, l/s, m3/s, m3/h and ACR (air change rate). A PID control output can be selected, whilst still having one output for monitoring the pressure or volume.

The pressure ranges can be adjusted via the keyboard, but the base range is factory calibrated and certified i.e. 10, 25, 50, 100, 250 and going up to 7500 Pa. All P-Sensors can be adjusted to +/- . The scaling can be changed to +/- 50% of the range via the keyboard. Power supplies are built in and can be ordered to be 24 Vdc/ac non-isolated or 24 or 110 or 230 Vac isolated.

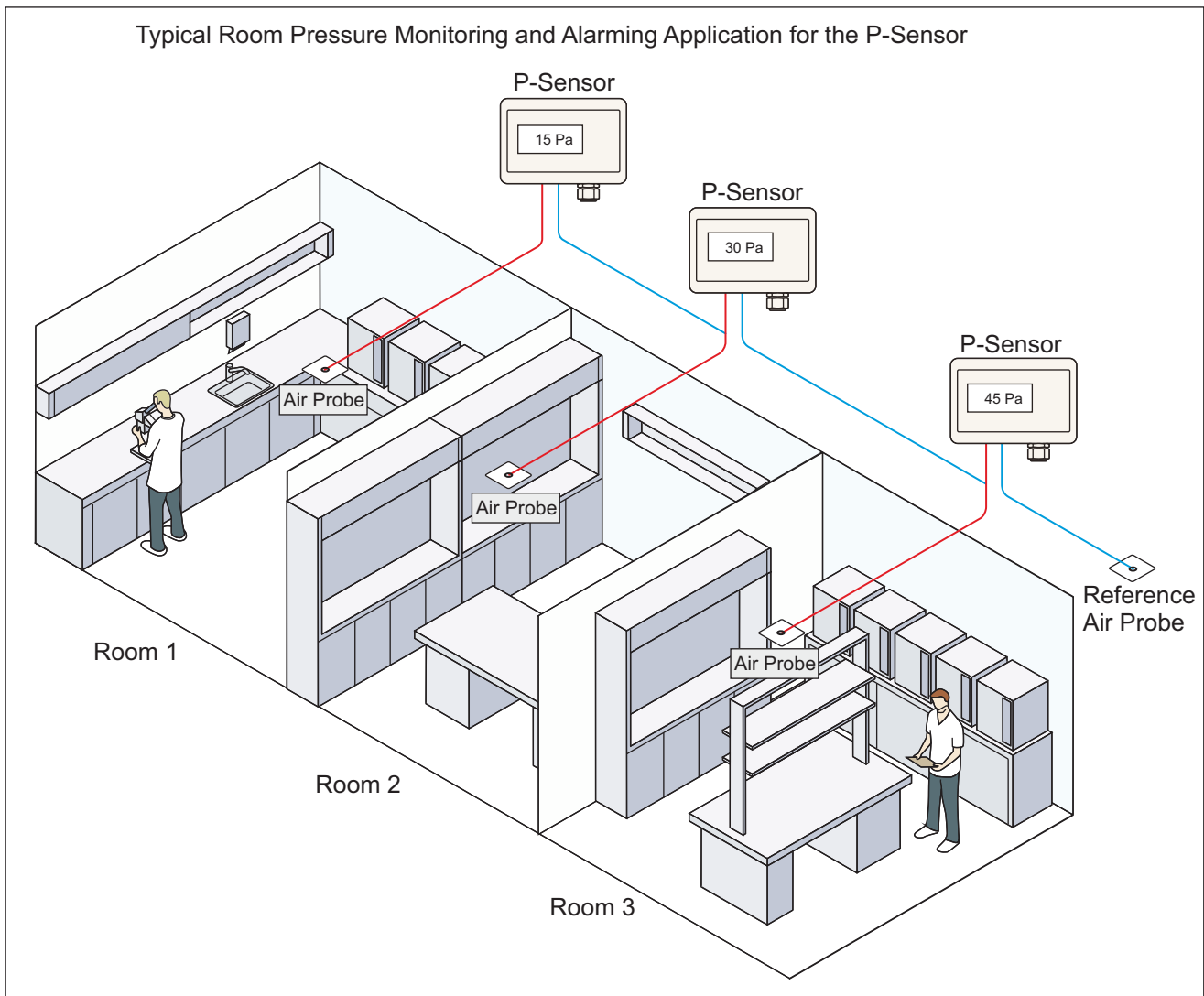

# P-SENSOR AIR PRESSURE APPLICATION

## ROOM PRESSURE MEASUREMENT WITH CMR P-SENSORS



Tubes + Fittings



Ceiling Air Probe



Air Probe Plate

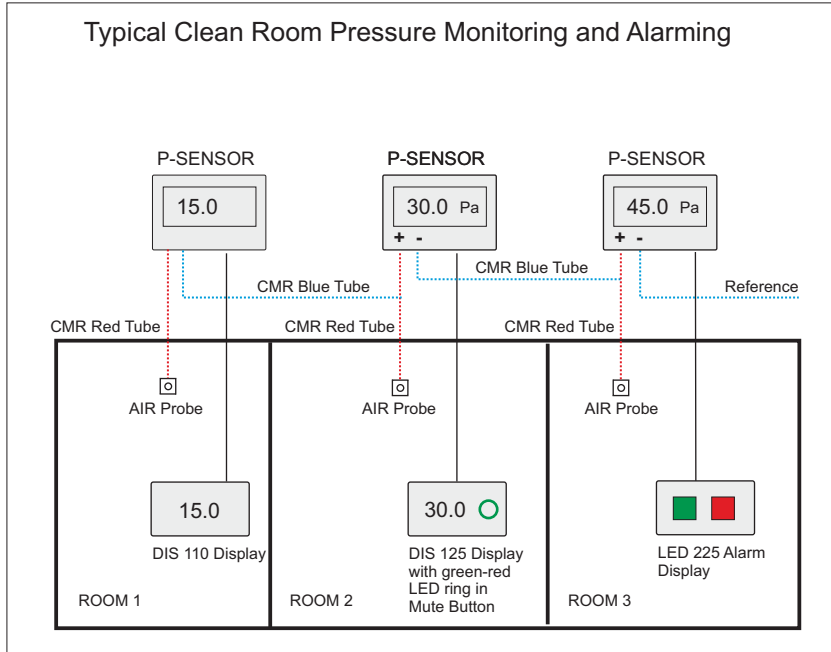

DIS 110 Display



DIS 125 Display



LED 225 Display

The above schematic shows a typical clean room. The room pressures are measured in cascades starting in room 1, then measuring across to room 2 and finally across to room 3 which is measured against a reference such as a plant room or any other stable location. Each room has an air probe plate fitted to the ceiling. The air probes are connected to the P-Sensors with red and blue CMR Tubing.

The P-Sensor is a true low differential air pressure transmitter and can be used for static pressure, vacuum pressure and differential pressure measurements in positive or negative areas.

The operator keyboard with LCD display is fitted into the lid as standard and shall display the actual pressure. All parameters can be adjusted without opening the lid.

The CMR tubing can be run up to 200 m from the room to the P-Sensor without losing accuracy of the measurement. Remote LED display plates can be fitted for the operators to see the actual room pressure in room 1 and 2. Room 2 has also a local illuminated alarm green and red led built as ring into the mute button and a buzzer. Room 3 has only a alarm led indicator plate. The remote plates must be powered separately 24 Vac or dc.

The pressure measurement can be transmitted via Modbus rtu or analogue signals 0-10 V or 4-20 mA to the SCADA, BMS or industrial PLC systems for long term monitoring.

All future calibration can be done using the calibration mode. Calibration certificates traceable to national and international Standards (UKAS) are supplied as standard with all P-Sensors.

## TYPICAL PRESSURE APPLICATIONS

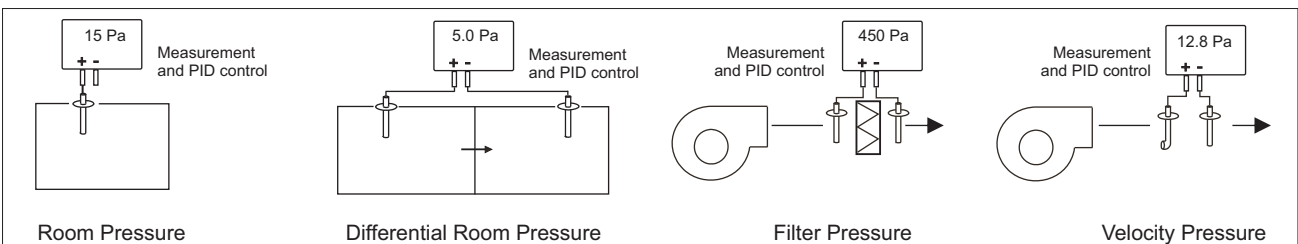
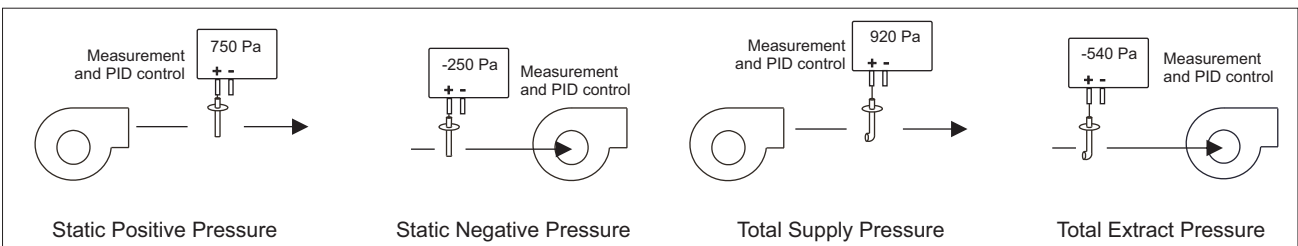

# P-SENSOR AIR VOLUME APPLICATIONS

VELOCITY PRESSURE AND AIR VOLUME MEASUREMENT WITH CMR P-SENSORS

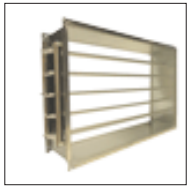

FGG Flowgrid



VVM Venturi



PVC Tube Fittings

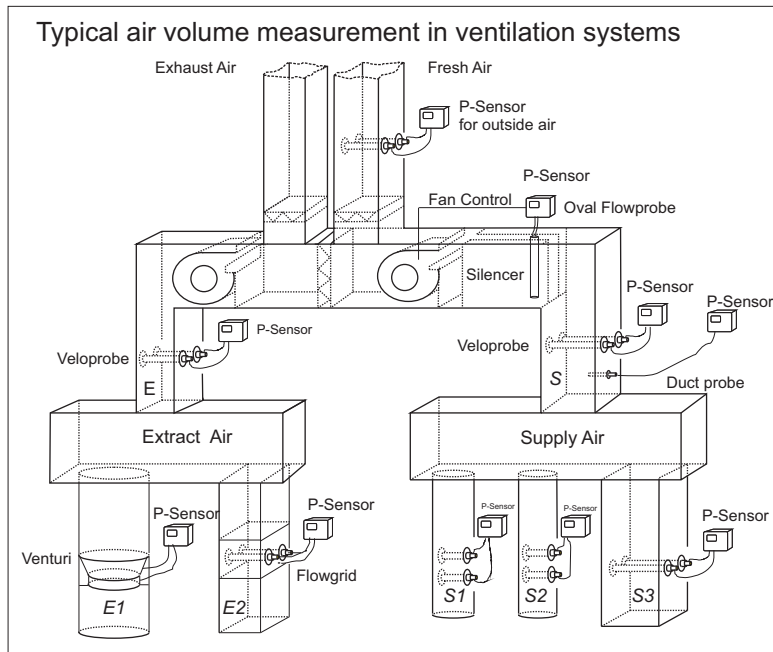

CMR Veloprobes



Duct Probes



Oval Flowprobe

The CMR P-Sensor is an ultra low high precision velocity pressure transmitter which has been designed to accurately measure air volumes in ventilation ducts. The built in Square Root Extraction and Magnification Factor or K-Factor Scaling makes the P-Sensor an extremely versatile measurement instrument.

The P-Sensor is used for monitoring and also controlling volume flow in commercial or process applications and is designed to be connected to any CMR Veloprobes, Duct Probes, Flowgrids, Venturis and Fan Inlet Rings. It can also be used with any existing or custom made duct flow measurement device.

It can display the actual volume in m<sup>3</sup>/s. Other units such as m/s, m<sup>3</sup>/h, litres/s or ACR can be selected via the keyboard. Any imperial measurement units i.e. CFM are available on request.

The measured values can be transmitted to remote display plates, SCADA, BMS control systems or industrial PLCs through the output signals of 0-10 V, 4-20 mA and Modbus.

The CMR tubing can be run up to 200 m from the sensing station to the P-Sensor without losing the accuracy of the measurement.

Calibration certificates traceable to national and international Standards (UKAS) are supplied with all P-Sensors.

## TYPICAL CMR AIR VOLUME MEASUREMENT APPLICATIONS

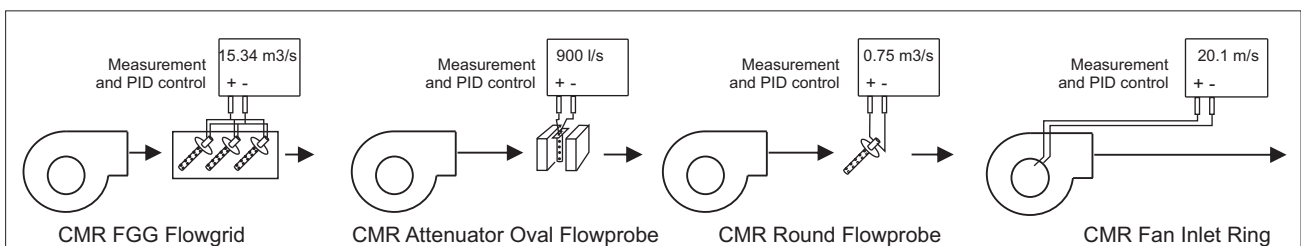
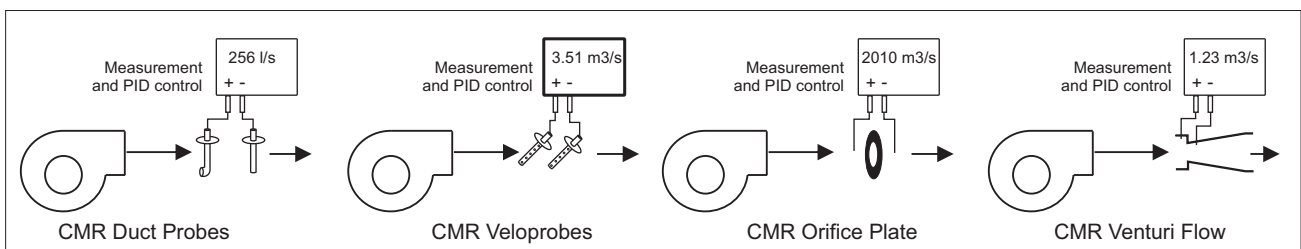

**CMR CONTROLS** Ltd  
Precision Air Pressure and Volume Sensors

22 Repton Court Repton Close  
Basildon Essex SS13 1LN GB  
web www.cmr-controls.com

Phone +44 (0) 1268 287222  
Fax +44 (0) 1268 287099  
mail sales@cmr-controls.com



# P-SENSOR VELOPROBE MEASUREMENT

## GENERAL

The drawing shows a typical application for CMR Veloprobes and P-Sensors.

The supply air duct can either be fitted with one central Veloprobe or individual Veloprobes on each of its branches.

In many cases, the positions of the Veloprobes are very much dictated by the design of the building. The CMR Veloprobe can be fitted in almost any position in order to provide accurate measurements.

In a single supply and extract duct application, the P-Sensor measures the building's actual total supply and return volumes. As both P-Sensors are calibrated to provide a linear air volume signal, tracking of supply and extract air is now made easy.

The duct height, width or diameter, density and magnification ('K' factors) can be entered in the P-Sensor via the keyboard very easily and only the measurement range for 0-10 V or 4-20 mA must be given to the BMS at final commissioning.

For multiple duct applications, the total supply and extract air volume is derived by adding all air volumes from the individual ducts.

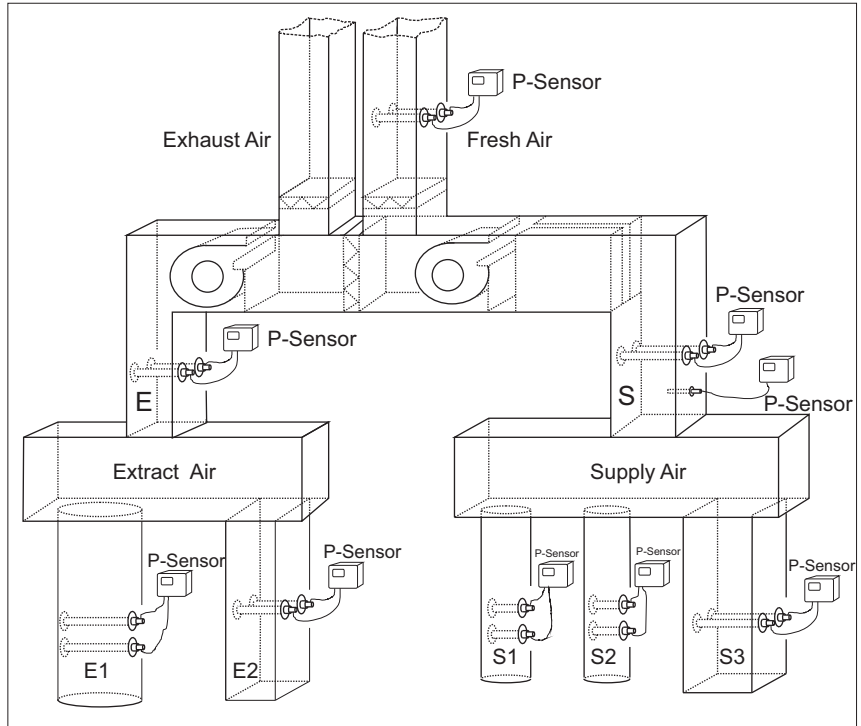

Example of Volume adding:  $S = E \pm \text{an offset for positive or negative building pressure}$   
 $S1 + S2 + S3 = E1 + E2 \pm \text{offset}$  or  $S = E1 + E2 \pm \text{offset} - \text{etc.}$

### P-Sensor - scaling in m/s only

Adjust the Impact Veloprobe (red) to face the airflow and and adjust the Static Veloprobe (blue) to approx. 180° away from the airflow.

### Scaling the range in the P-Sensor

Use the display on the menu and select m/s and adjust the decimal places. Use the Flow Scaling Menu and enter the magnification factor (mf) to i.e. 2.000.

The Information screen shall show the range in the selected units at 10V or 20mA. Take a Pitot Tube reading in the duct. If the average velocity is not equal to the display then adjust the magnification factor until it is equal.

### P-Sensor - scaling in m3/s - m3/h - l/s - ACR air change rate

Adjust the Impact Veloprobe (red) to face the airflow and and adjust the Static Veloprobe (blue) to approx. 180° away from the airflow.

### Scaling the range in the P-Sensor.

Use the display on the menu and select m3/s, m3/h, l/s or ACR (Air Change Rate) and adjust the decimal places. Use the Flow Scaling Menu and enter duct height and width or simply enter the width of a round duct and keep the height at 0. Enter the room size for ACR. Adjust the magnification factor (mf) to i.e. 2.000. The Information screen shall show the range in the selected units at 10V or 20mA. Take a Pitot Tube reading in the duct. If the volume is not equal to the display then adjust the magnification factor until it is equal.

## P-Sensor air volume measurement with Veloprobes built into the duct

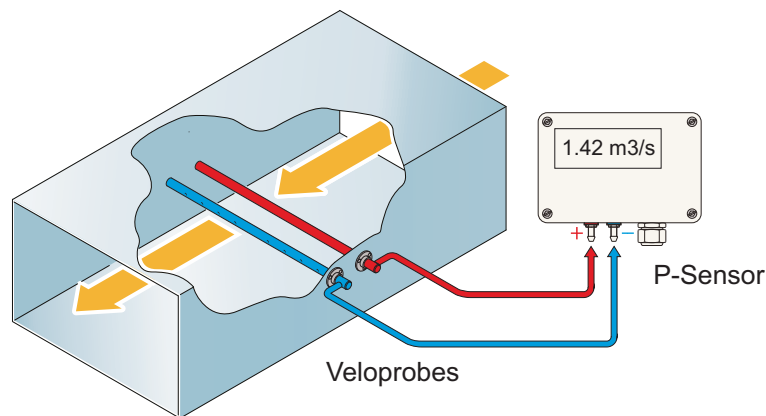

# P-SENSOR GENERAL DESCRIPTION

**FUNCTIONS** (Use Operator Manual for full Instructions)

## KEYBOARD DISPLAY

A combined keyboard and LCD display is fitted into the lid and is connected to the P-Sensor board with a plug-in ribbon cable. All parameters can be accessed via the key pad. The display can also be programmed to switch off after a time and by touching a key to light up again. It is factory set to 'on'.

## PARAMETER CONFIGURATION

The duct width and height can be entered as well as the density and (mf) magnification (K) factors to scale Fan Inlet Rings, Flowgrids, Veloprobes, Oval Flowprobes, Venturis or any other velocity pressure producing probes. The volume can be linearized over 8 points to provide extremely high accuracy in measurement.

The range can be changed from +/- 50% of the nominal range. The output signals can be changed to 2-10 V, 1-5 V or 5-19 mA.

The auto zero function is built in, which is of great advantage at very low velocity pressure measurement have an accurate base point at all times. The auto zero can be turned off where it is not required.

The overload protection can be switched on and is ideal to protect the low pressure diaphragm. It is active whenever the sensor is powered up.

One of the outputs can be configured to be a PID control to drive fan inverters or modulating dampers and the other can be used for the actual pressure or air volume measurement for the BMS or PLC system. The set point can be sent from the BMS via Modbus.

The signals can be individually smoothed. The control output can be fast but the measurement output can be dampened.

A calibration mode can be selected so that all of the parameters remain the same as commissioned and only the base sensor shall be calibrated and displayed in Pa.

## MODBUS rtu COMMUNICATION

The Modbus communication can be used to read and write all parameters by the remote host which can be the BMS, PLC or PC.

## CMR TRANSDUCER

The transducer is manufactured by CMR with high precision engineered components. The principle is the measurement of the displacement of the diaphragm by means of a push and pull variable reluctance circuit which is not affected by humidity and hence it can be used in any industrial or commercial environment. There are no mechanical connections to any of the sensing coils and the diaphragm.



CMR Transducer

Extremely low pressures can be measured with excellent repeatability and minimal hysteresis. The diaphragm displacement is so small that no air volume is required to measure the air pressure which means measurement tubing can be connected in excess of 200 m throughout the building without losing accuracy or measurement speed.

The zero drift is minimized by the measuring copper coils which are matched to provide excellent self compensation. One coil measures positive and the other negative drift and therefore balances any excessive drift between two tolerance limits in its life cycle. The CMR Transducer has a proven field track record of over 40 years. All CMR Sensors are temperature compensated in a computerised climate chamber.



CMR Climate Chamber

## P-SENSOR WITH STANDARD LCD DISPLAY AND KEYBOARD

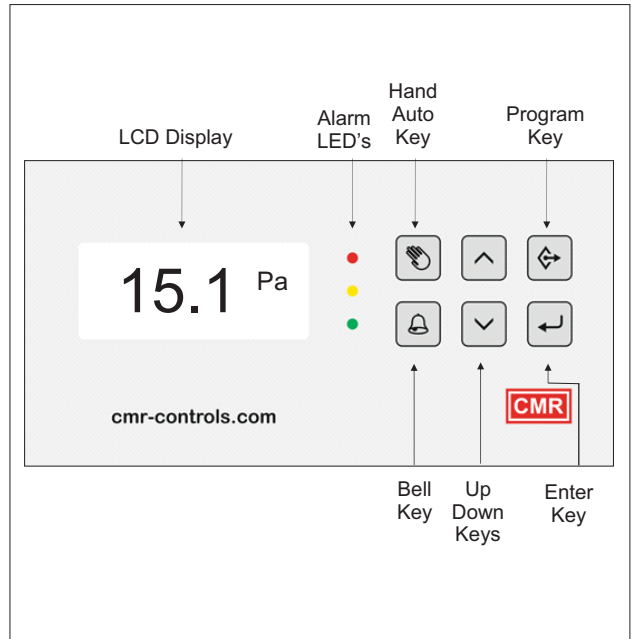

## P-SENSOR Circuit Board

The P-Sensor Circuit Board has been designed to be flexible and has many functions on board which can also be used for custom OEM applications. It is best to consult CMR to explore all possibilities. The LCD display and keyboard are standard and the operating manual provides all the adjustable function descriptions and instructions to utilise all the features.

## Power Supplies

The P-Sensor has to be ordered with the correct power supply.

- Non isolated 3 or 4 wire - 24 Vdc/ac
- Isolated 4 wire 24 Vac with built in internal transformer
- Isolated 4 wire 110 Vac with built in internal transformer
- Isolated 4 wire 230 Vac with built in internal transformer.

## Output Signals

- 0-10 V and 4-20 mA - at the same time
- One can be programmed as PID control output
- Modbus rtu.

## P-SENSOR CIRCUIT BOARD

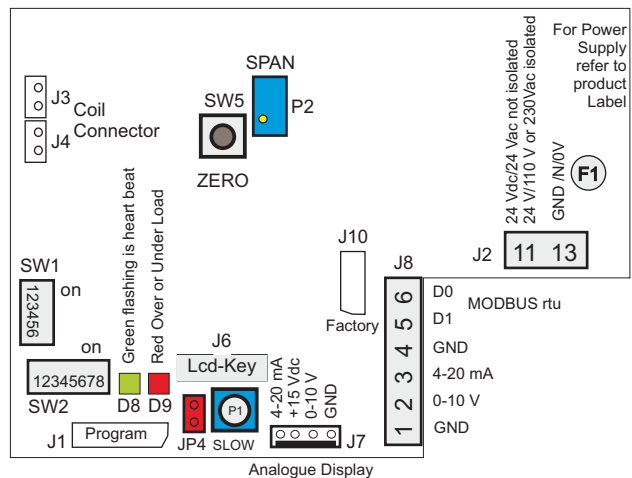



# P-SENSOR (LCD) ORDER DESCRIPTION

## GENERAL

CMR manufactures the P-Sensors to suit many low pressure and volume measurement applications. Because of the variety of pressure ranges, output signals and power supplies it has been necessary to design an easy to use selection table for anybody to make up a P-Sensor specification to satisfy a requirement. On the P-Sensor selection table you will find all specifications available with the associated ordering code.

## P-SENSOR BASE PART NUMBER

The P-Sensor part number starts with a base part number of the type of sensor. Code '23' which is a P-Sensor in a standard ABS enclosure.

The part number therefore starts with '23'.

## P-SENSOR Display Type

The P-Sensor will have a number to identify the display model. The Code is '2' for LCD Display.

The part number extends to '232' for LCD display.

## TUBE CONNECTORS

6 mm barbed nipples to fit CMR Tube are fitted as standard into the ABS box. They have the Code 'A'.

4 mm barbed nipples to suit the CMR Silicone Tube are also available as Code 'B'.

The example has 6 mm barbed nipples, which is standard.

The part number therefore extends to '232A'.

## NEGATIVE PRESSURE RANGE

The negative range is specified as (-). If the application requires to measure a negative pressure against a reference, i.e. a room has to be at negative pressure compared with the corridor, then the room has to be connected to the red or (+) nipple. The blue (-) nipple shall be connected to the reference in this case the corridor.

The negative room pressure shall suck on the red (+) nipple and the P-Sensor produces an output signal equivalent of the negative pressure measured.

In the example we have chosen -25 which has the Code '0025'.

The part number extends to '232A0025'.

If the P-Sensor must only measure in the positive range i.e 0-25 then the negative range will always be selected as 0 and the Code is always '0000'.

## PRESSURE UNITS

The negative pressure and the positive pressure range must be expressed in units i.e. Pa. The CMR transducers are in Pascals (Pa) as standard.

In the example Pa was selected with Code 'P'.

The part number extends '232A0025P'.

## POSITIVE PRESSURE RANGE

To measure positive pressure against a reference it is necessary to select a positive range i.e. +25. The Code is '0025'.

This means the P-Sensor selected above can measure from - 25 Pa to 0 and from 0 to +25 Pa.

The output voltage would therefore be 5 V or 12 mA at 0 Pa.

The part number extends to '232A0025P0025'.

## LCD DISPLAY UNITS

As the P-Sensor has an LCD Display the units shall be factory configured to show Pa, kPa, mB, m/s, m3/s, m3/h, l/s etc. It is good to specify the units when selecting the part number as this is all part of the validation of the instrument.

In the example Code 'P' for Pa was selected.

The part number extends to '232A0025P0025P'.

## OUTPUT SIGNAL

The industry standards for output signals are 0-10 V or 4-20 mA, but other signals can be adjusted via the keyboard.

If 0-10 V is the output signal for -25 Pa to +25 Pa, then 5 V is 0 Pa.

From 5 V to 0 V the P-Sensor measures from 0 Pa to - 25 Pa i.e. (-)12.5 Pa would be 2.5 V.

From 5 V to 10 V the P-Sensor would measure positive pressure from 0 Pa to +25 Pa i.e. +12.5 Pa would be 7.5 V.

It is standard to use equal ranges -25 Pa to +25 Pa rather than -25 Pa to +50 Pa but the P-Sensor can be adjusted via the keyboard to provide any offset.

In the example, we have selected the standard Dual (0-10 V & 4-20 mA) which has the Code '1'.

The part number extends to '232A0025P0025P1'.

## POWER SUPPLY

CMR can supply 24 Vdc/24 Vac non-isolated which does not have an isolation transformer and is also suitable for 3-Wire connection. CMR has also a 24 Vac transformer isolated version which at present is very popular for long distance power up solutions but more 24 Vdc units are used to suit the BMS Power Supplies.

110 Vac and 230 Vac are less used, but also selectable. In the example we have selected 24 Vac transformer isolated power supply which has the Code '3'.

The part number extends to '232A0025P0025P13'.

## FINAL PART NUMBER

The part number to order is '232A0025P0025P13'.

**Now try and select your own P-Sensor using the P-Sensor Order Selection Table.**

# P-SENSOR ORDER SELECTION TABLE

The selection table has been prepared to make ordering easy. Each column contains a number of different options which are available and a part number can be established depending on a specific requirement.

The example part number 232A0025P0025P13 which is printed above the selection table is identified as being a P-Sensor with ABS enclosure, having a base part Number, an LCD Display, 6 mm barbed tube connectors, a negative pressure range of -25, range units in Pa (Pascals) and a positive range of +25, LCD configured in Pa (Pascals) with dual output signals of 0-10 V & 4-20 mA, which would mean in this case 0 Pa is 5 V & 12 mA. The power supply is an isolated 24 Vac (4 wire).

The P-Sensor would be supplied with an LCD-display-keyboard mounted into the lid and the measured units are Pa (Pascals). The decimal point is user adjustable to 1 on the keyboard which indicates from -25.0 Pa to +25.0 Pa. It comes standard with a traceable calibration certificate to national and international Standards (UKAS).

## EXAMPLE PART NUMBER SELECTION ( The code after the (=) sign is used i.e. 6 mm = A)

23	2	A	0025	P	0025	P	1	3
P-Sensor	Display	Nipple	Negative	Range	Positive	Display	Output	Power
Part No.	Type	Size	Range	Units	Range	Units	Signal	Supply
Base = 23	LCD = 2	6 mm = A	0000	Pa = P	0000	Pa = P	Dual = 1	24 Vdc/ac = 2
		4 mm = B	0010		0010	kPa = K		24 Vac = 3
			0025		0025	mB = B		110 Vac = 4
			0030		0030	m/s = V		230 Vac = 5
			0050		0050	m3/s = Q		
			0060		0060	m3/h = M		
			0100		0100	l/s = L		
			0120		0120	ACR = A		
			0125		0125			
			0150		0150			
			0200		0200			
			0250		0250			
			0500		0500			
			0750		0750			
			1000		1000			
			1250		1250			
			1500		1500			
			2000		2000			
			2500		2500			
			5000		5000			
			7500		7500			

## HOW TO ORDER

--	--	--	--	--	--	--	--	--

### EXAMPLE

A wall mount pressure transmitter is required of the type P-Sensor  
 An LCD complete with keyboard is required as standard.  
 The tube connections must be 6 mm for CMR Tube.  
 The negative pressure range must be -100 Pa  
 The measured units must be in Pascals (Pa)  
 The positive pressure range must be +100 Pa  
 The units on the LCD display must be configured in Pa to show on the LCD display  
 The output signal must be dual (0-10 V & 4-20 mA)  
 The power supply must be 24 Vdc non-isolated.

Call CMR for assistance at any time.

The part number for this P-Sensor is 23 2 A 0100 P 0100 P 1 2.

# P-SENSOR with LCD

# SPECIFICATION

Measurement Range	Any Range from 0-10 Pa or +/-25 Pa up to 0-10000 Pa or +/-10000 Pa
Overload Capacity	Ranges 10 Pa - 150 Pa up to max 1200 Pa if over pressure protection is off.
	Ranges from 200 Pa - 10000 Pa up to max 10 times of range if over pressure protection is off.
Media	Non corrosive gases such as Air, N <sub>2</sub> , O <sub>2</sub> , Co <sub>2</sub> , N <sub>2</sub> O and inert gases.
Diaphragm Unit	Beryllium Copper suitable for high concentration of Formaldehyde - Stainless steel on request.
AC Power Supplies	24 Vac 50/60 Hz 130 mA. Internal Fuse 300 mA Auto-Reset.
Transformer Isolated	110 Vac 50/60 Hz 32 mA. Fuse 315 mA Wickmann.
	230 Vac 50/60 Hz 16 mA. Fuse 315 mA Wickmann.
DC/AC Power Supplies	24 Vdc (19 to 31 Vdc) smoothed 80 mA or 24 Vac non isolated. Internal Fuse 300 mA Auto-Reset.
Voltage Output Signal	0-10 V (0 to 100% of Range) RL = 5 kOhm min. Other output signals (e.g. 2-10 V) or PID loop control is programmable via keyboard.
Current Output Signal	4-20 mA (0 to 100% of Range) RL = 500 Ohm max. Other output signals (e.g. 0-20 mA) or PID loop control is programmable via keyboard.
Modbus rtu Connection	Output Signal, Alarm Status, Alarm Thresholds and Alarm Timers are all readable as Modbus rtu commands. Modbus rtu register assignments to read and write are available in the operator manual.
Hysteresis/Repeatability	0.1% Typical of Full Scale.
Linearity (Accuracy)	+/- 0.25% of Full scale = > 100 Pa and 0.25 Pa < 100 Pa.
Zero Drift	0.05% K (+10°C to +50°C) - Automatically corrected to 0.0 if Auto-Zero function is enabled.
Operating Temperature	-10°C to +70°C.
Mounting Position	Vertical.
Weight	0.6 kg in ABS Housing.
Electrical Connections	ABS Housing: 1 x M20 Gland for 24 Vac/dc-110 Vac. Removable Screw Terminals.
Air Tube Connections	ABS Housing: Positive and negative pressure barbed nipple 6 mm OD x 15 mm long for CMR tube. Alternatively barbed nipple 4 mm OD x 15 mm long for silicone tube on special request.
Enclosure	Plastic (ABS) Light Grey (RAL7035) - Protection IP65.
Conformity	EN61326-1 EMC - EN61010-1 SAFETY.
Calibration Certificate	Supplied with certificate traceable to national and international Standards (UKAS traceable).

## DIMENSIONS AND CONNECTIONS

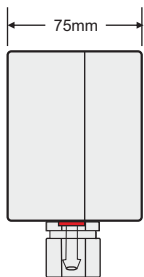
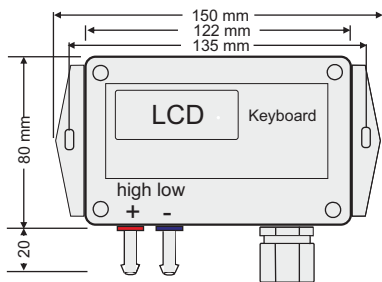

P-Sensor with LCD Display  
in ABS Enclosure

TUBE CONNECTIONS  
2 x 6 mm Barbed x 15 mm for  
CMR tube

CABLE ENTRY 24 Vac/dc - 110 Vac  
1 x M20 Gland for ABS Enclosure

